

# General Hardware & Tools

# General Hardware and Tools

## Product guide

### Cabinet Hardware

|                                 | Page |
|---------------------------------|------|
| Bed Fittings                    | 5.3  |
| Joiners and Connectors          | 5.4  |
| Brackets                        | 5.5  |
| Cable Entry Grommets            | 5.6  |
| Castors                         | 5.7  |
| Door Catches and Latches        | 5.9  |
| Clips                           | 5.12 |
| Bump-ons, Protectors and Glides | 5.13 |
| Shelf Supports                  | 5.17 |

### Furniture Locks

|                         | Page |
|-------------------------|------|
| Cylinder Locks          | 5.19 |
| Striker Plates          | 5.23 |
| Espagnolette Locks      | 5.24 |
| Central Locking Systems | 5.25 |

## General Hardware & Tools

Page

Waste Plates 5.26

Drill Bits 5.27

Saw Blades 5.30

Files 5.31

Tool Storage 5.31

Liquid Laminate 5.32

Repair Crayons 5.33

Fillers 5.34

Stan the Stand 5.35

## Safety Materials

Page







Nuisance Dust Mask 5.36

Disposable Respirators 5.36

Disposable Ear Plugs 5.36

# Cabinet Hardware

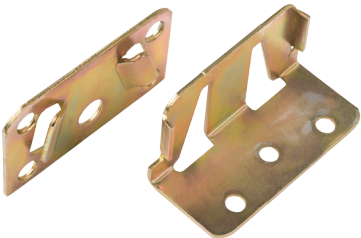
## Bed Fittings

|   | Length (mm) | Item number      |
|---|-------------|------------------|
| <p><b>Bed Bracket</b></p>  <p> 1 Set</p> <p>Made of steel</p>                  | 120         | 605.8B22.192.000 |
| <p><b>Bed Fittings for Water Beds</b></p>  <p> 1 Set</p> <p>Made of steel</p> |             | 605.8B22.190.000 |
| <p><b>Bed Fitting Centre Rail</b></p>  <p> 1 Set</p> <p>Made of steel</p>     | 70          | 605.8B22.191.000 |

Download supporting documentation from the Titus Tekform website [titustekform.com.au](http://titustekform.com.au)



# Cabinet Hardware

## Joiners and Connectors

|  |        | Length (mm) | Width (mm) | Item number      |
|--|--------|-------------|------------|------------------|
| <b>Benchtop Connector, Ø35mm</b><br><br> 100 Pcs<br>Made of steel               |        | 65          |            | 605.8A24.035.065 |
| <b>Steel Figure 8 Joiner</b><br><br> 100 Pcs<br>Made of steel                  |        |             | 1.65       | 605.8A24.080.000 |
| <b>Benchtop Connector Plate, Black</b><br><br> 350 Pcs<br>Made of plastic      |        | 118         | 73         | 605.8A24.118.730 |
| <b>Zipbolt Benchtop Connector</b><br><br> 250 Pcs<br>Made of plastic and metal | Ø25mm  | 85          |            | 605.8A24.025.025 |
|  | Ø35mm  | 85          |            | 605.8A24.085.035 |
| <b>Wood Joiner Biscuits</b><br><br> 1 Box<br>Made of MDF                       | No. 0  |             |            | 605.8A26.021.000 |
|  | No. 5  |             |            | 605.8A26.021.050 |
|  | No. 10 |             |            | 605.8A26.021.010 |
|  | No. 20 |             |            | 605.8A26.021.020 |

# Cabinet Hardware

## Bracket

|   | Length (mm) | Width (mm) | Item number      |
|---|-------------|------------|------------------|
| Angle Brackets, Zinc Plated   | 22          | 22         | 605.8A26.025.025 |
|   | 38          | 38         | 605.8A26.038.038 |
|   | 50          | 50         | 605.8A26.050.050 |
| <p>  1000 Pcs/Bag (605.8A26.025.025)<br/>           250 Pcs/Bag (605.8A26.038.038)<br/>           200 Pcs/Bag (605.8A26.050.050)         </p> <p>Made of steel</p> |             |            |                  |

# Cabinet Hardware

## Cable Entry Grommets and Cap Holes

|   | Colour  | Diameter (mm) | Item number      |                  |
|---|---|---------------|------------------|------------------|
| <p><b>Cable Entry Grommets</b></p>  | White   | 60            | 605.8A30.060.001 |                  |
|   | Black   | 60            | 605.8A30.060.002 |                  |
|   | Beige   | 60            | 605.8A30.060.003 |                  |
|   | Cream   | 60            | 605.8A30.060.004 |                  |
|   | Silver Grey   | 60            | 605.8A30.060.016 |                  |
|   | Dove Grey   | 60            | 605.8A30.060.007 |                  |
|   | White   | 80            | 605.8A30.080.001 |                  |
|   | Black   | 80            | 605.8A30.080.002 |                  |
|   | Beige   | 80            | 605.8A30.080.003 |                  |
|   | Cream   | 80            | 605.8A30.080.004 |                  |
|   | Grey  | 80            | 605.8A30.080.007 |                  |
|   | Silver Grey   | 80            | 605.8A30.080.016 |                  |
|   | <p> 1 Pce      Made of plastic</p> |               |                  |                  |
|   | <p><b>Cap Holes</b></p>            | White         | 35               | 605.8A31.035.001 |
| <p> 1 Pce      Made of plastic</p> |   |               |                  |                  |

# Cabinet Hardware

## Castors







|   | Wheel diameter (mm) | Item number      |
|---|---------------------|------------------|
| <p>Castor, Unhooded with Socket</p>  <p>1 Set<br/>Made of plastic and steel</p>             | 40                  | 605.8A50.402.000 |
| <p>Castor, Hooded without Brake</p>  <p>1 Pce<br/>Made of plastic and steel</p>            | 42                  | 605.8A50.422.000 |
| <p>Castor, Hooded Heavy Duty without Brake</p>  <p>1 Pce<br/>Made of plastic and steel</p> | 50                  | 605.8A50.503.000 |
| <p>Castor, Hooded Heavy Duty with Brake</p>  <p>1 Pce<br/>Made of plastic and steel</p>    | 50                  | 605.8A50.504.000 |

Download supporting documentation from the Titus Tekform website [titustekform.com.au](http://titustekform.com.au)



# Cabinet Hardware

## Castors

|  |               | Wheel diameter (mm) | Item number      |
|--|---------------|---------------------|------------------|
| <b>Castor, Swivel, 30kg</b><br><br>.501.001                      .502.001<br> 1 Pce                      Made of rubber               | With brake    | 50                  | 605.8A50.501.001 |
|  | Without brake | 50                  | 605.8A50.502.001 |
| <b>Castor, Heavy Duty Rigid, 200kg</b><br><br> 1 Pce                      Made of plastic  |               | 80                  | 605.8A50.801.002 |
| <b>Castor, Heavy Duty Swivel, 200kg</b><br><br>.802.002                      .803.000<br> 1 Pce                      Made of plastic | With brake    | 80                  | 605.8A50.803.000 |
|  | Without brake | 80                  | 605.8A50.802.002 |

# Cabinet Hardware

## Door Catches and Latches

|  |  | Item number      |
|--|--|------------------|
| <p>Double Ball Catch</p>  <p>10 Pcs</p> <p>Made of brass</p>           |  | 605.8A36.010.000 |
| <p>Gripper Catch</p>  <p>100 Pcs</p> <p>Made of steel and plastic</p> |  | 605.8A36.010.010 |
| <p>Roller Catch</p>  <p>100 Pcs</p> <p>Made of zinc</p>               |  | 605.8A36.010.020 |
| <p>Daisy Inline Catch</p>  <p>50 Pcs</p> <p>Made of plastic</p>       |  | 605.8A36.020.001 |
| <p>Daisy Side Mount Catch</p>  <p>50 Pcs</p> <p>Made of plastic</p>   |  | 605.8A36.025.001 |

Download supporting documentation from the Titus Tekform website [titustekform.com.au](http://titustekform.com.au)







# Cabinet Hardware

## Door Catches and Latches

|  | Item number    | White |
|--|----------------|-------|
| <p><b>Mini Touch Latch</b></p>  <p>50 Pcs</p> <p>Made of steel and plastic</p>     | 605.8A36.010 → | 030   |
| <p><b>Corna Side Bi-fold Door Catch</b></p>  <p>25 Pcs</p> <p>Made of plastic</p> | 605.8A36.030 → | 001   |
| <p><b>Corna Top Mount Catch</b></p>  <p>150 Pcs</p> <p>Made of plastic</p>        | 605.8A36.030 → | 002   |

# Cabinet Hardware

## Door Catches

|  |                           | Item number  |
|--|---------------------------|--|
| <b>Corna Slide Door Protector Catch</b>  |                           | 605.8A36.030.003   |
|  25 Pcs                                 | Made of plastic           |  |
| <b>Magnetic Catch, 6kg</b>              |                           | White 605.8A36.040.061<br>Brown 605.8A36.040.064<br>Includes steel striker plate |
|  100 Pcs                                | Made of steel and plastic |  |
| <b>Catch Striker Plate</b>              |                           | 605.8A36.040.000<br>To use with magnetic catch                                   |
|  1 Pce                                  | Made of steel             |  |

Download supporting documentation from the Titus Tekform website [titustekform.com.au](http://titustekform.com.au)





# Cabinet Hardware

## Clips

|   | Size (mm)    | Colour           | Item number      |
|---|--------------|------------------|------------------|
| <b>Table Clip</b><br><br> 1000 Pcs<br>Made of steel                  | 3.65 x 1.85  | Gold zinc plated | 605.8A32.365.185 |
| <b>Playground Clip</b><br><br> 250 Pcs<br>Made of steel             | 60mm         | Zinc plated      | 605.8A32.500.000 |
| <b>Mirror Clip</b><br><br> 250 Pcs<br>Made of plastic               | 4mm          | Clear plastic    | 605.8A32.500.050 |
| <b>Cleat Easy Clip Connector</b><br><br> 100 Pcs<br>Made of plastic | 50 x 16 x 20 | White            | 605.8A36.056.080 |
| <b>Door Stop with Clip</b><br><br> 1 Pce<br>Made of plastic         |              | White            | 605.8A36.010.040 |

# Cabinet Hardware

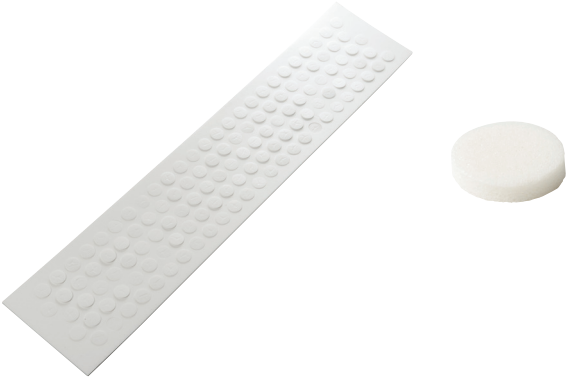
## Bump ons

|  |  | Thickness (mm)  | Diameter (mm) | Item number      |
|--|--|-----------------|---------------|------------------|
| <b>Clear Bump On</b><br>   |  | 3               | 10            | 605.8A28.000.030 |
|  |  | 1.5             | 10            | 605.8A28.000.015 |
|  |  | 2.2             | 7.9           | 605.8A28.079.022 |
|  |  | 2.2             | 8.5           | 605.8A28.085.022 |
|  |  | 4.8             | 9.5           | 605.8A28.095.048 |
|  |  | 1.5             | 12.7          | 605.8A28.127.015 |
|  |  | 3.8             | 12.7          | 605.8A28.127.038 |
|  450 Pcs/Card, 12 Cards/Box (605.8A28.079.022, 605.8A28.085.022)<br>200 Pcs/Card, 25 Cards/Box (All others) |  | Made of plastic |               |                  |
| <b>White Bump On</b><br>  |  | 3               | 12            | 605.8A28.000.003 |
|  125 Pcs/Card, 8 Cards/Box  |  | Made of foam    |               |                  |

Download supporting documentation from the Titus Tekform website [titustekform.com.au](http://titustekform.com.au)







# Cabinet Hardware

## Corner Protectors and Glides

|   | Colour  | Length (mm) | Width (mm) | Item number      |
|---|---------|-------------|------------|------------------|
| <b>Corner Block</b><br>   | Natural | 45          | 20         | 605.8A36.045.200 |
|   | Natural | 60          | 20         | 605.8A36.060.600 |
|  100 Pcs <span style="margin-left: 200px;">Made of plastic</span>      |         |             |            |                  |
| <b>Corner Protector Glide, 45°</b><br>                                 | White   |             |            | 605.8A36.054.001 |
|  5000 Pcs/Bag <span style="margin-left: 200px;">Made of plastic</span> |         |             |            |                  |
| <b>Corner Protector Glide</b><br>                                      | White   |             |            | 605.8A36.050.001 |
|  100 Pcs <span style="margin-left: 200px;">Made of PVC</span>          |         |             |            |                  |

# Cabinet Hardware

## Corner Protectors and Glides

|  | Finish | Width (mm) | Item number      |
|--|--------|------------|------------------|
| <b>Tack-on Glide</b><br>   | Beige  | 16         | 605.A850.016.000 |
|  | Beige  | 19         | 605.A850.019.000 |
|  10000 Pcs <span style="margin-left: 200px;">Made of plastic</span> |        |            |                  |
| <b>Carpet Glide, Screw-on</b><br>                                   | Black  | 38         | 605.A850.038.002 |
|  1300 Pcs <span style="margin-left: 200px;">Made of plastic</span>  |        |            |                  |
| <b>Snap-off Furniture Wedge</b><br>                                 | Brown  |            | 605.A850.600.004 |
|  100 Pcs <span style="margin-left: 200px;">Made of plastic</span>   |        |            |                  |

Download supporting documentation from the Titus Tekform website [titustekform.com.au](http://titustekform.com.au)



# Cabinet Hardware

## Plinths and Glides

|   |          | Length (mm)               | Item number      |
|---|----------|---------------------------|------------------|
| Adjustable Plinth Foot Glide with Bracket and Cap                                   |          | 80                        | 605.8A50.510.050 |
|   | 200 Pcs  | Made of zinc-plated steel |                  |
| Adjustable Plinth Stem Glide  |          | 3/8 thread                | 50               |
|   |          | 5/16 thread               | 50               |
|  | 1000 Pcs | Made of steel and plastic |                  |
| Adjustable Glide Stem, Ø28mm Base   |          | 5/16 thread               | 50               |
|  | 1 Pce    | Made of steel and plastic |                  |

# Cabinet Hardware

## Shelf Supports

|   |           | Finish                    | Diameter (mm) | Item number      |
|---|-----------|---------------------------|---------------|------------------|
| <b>Shelf Support, Flat</b><br>            |           | Nickel Plated             | 5             | 605.8A38.119.650 |
|   |           | Brass Bush                | 8             | 605.8A38.180.010 |
|   |           | Nickel Plated             | 7.5           | 605.8A38.119.750 |
|  1000 Pcs (605.8A38.119.650, 5000 Pcs)   |           | Made of steel             |               |                  |
| <b>Shelf Support Bush</b><br>            |           | Nickel plated             | 7.5           | 605.8A38.175.651 |
|   |           | Brass Pin                 | 8             | 605.8A38.180.020 |
|  1000 Pcs                                |           | Made of steel             |               |                  |
| <b>Shelf Support with Safety Pin</b>  | 15 x 20mm | Nickel plated             | 5             | 605.8A38.214.650 |
|    |           |                           |               |                  |
|  1250 Pcs                                |           | Made of steel             |               |                  |
| <b>Shelf Support with Safety Pin</b><br> |           | Clear                     | 5             | 605.8A38.210.830 |
|   |           | White                     | 5             | 605.8A38.210.877 |
|  1000 Pcs                                |           | Made of steel and plastic |               |                  |
| <b>Shelf Support</b><br>                 |           | Nickel plated             | 5             | 605.8A38.216.650 |
|  1000 Pcs                                |           | Made of steel             |               |                  |

Download supporting documentation from the Titus Tekform website [titustekform.com.au](http://titustekform.com.au)

# Cabinet Hardware

## Shelf Supports

|  |                  | Finish        | Diameter (mm) | Item number      |
|--|------------------|---------------|---------------|------------------|
| <b>Shelf Support, Rock-in</b><br><br> 1000 Pcs<br>Made of steel   |                  | Nickel plated | 5             | 605.8A38.218.650 |
| <b>Shelf Support for Glass</b><br><br> 1000 Pcs<br>Made of steel and plastic   |                  | Nickel plated | 5             | 605.8A38.220.650 |
| <b>Centre Clips</b><br> .104.030<br> .104.020<br> 50 Pcs<br>Made of plastic | Without Grommets | Clear         |               | 605.8A60.104.030 |
|  | With Grommets    | Clear         |               | 605.8A60.104.020 |
| <b>End Clips</b><br> .106.030<br> .106.020<br> 50 Pcs<br>Made of plastic    | Without Grommets | Clear         |               | 605.8A60.106.030 |
|  | With Grommets    | Clear         |               | 605.8A60.106.020 |

# Furniture Locks

## Cylinder Lock

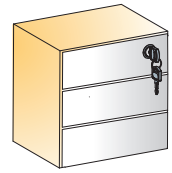
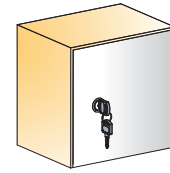

- Screw-on mounting on drawer front or door
- Left and right hand version available
- 800 key combinations

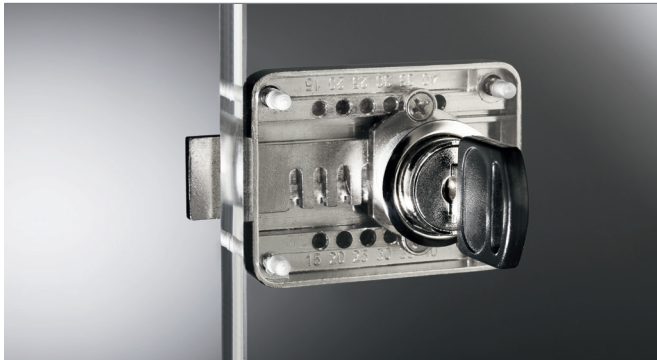

| D   | Left-hand    | Right-hand   |
|---|--------------|--------------|
| Drilling distance   |              |              |
|   | Item number  | Item number  |
| 30  | 104.7416.850 | 104.7413.850 |
| 35  | 104.7417.850 | 104.7414.850 |
| One set consists of   |              |              |
| Lock  |              | 1 pce        |
| Rosette   |              | 1 pce        |
| Key   |              | 1 pair       |
| Cylinder drilling distance can be adjusted<br>adjustment range: 15-40mm |              |              |

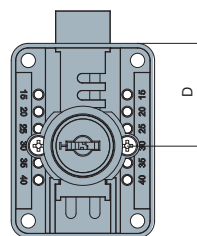
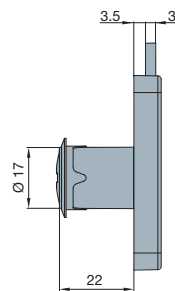
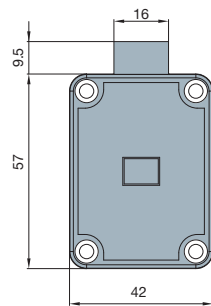

### Mounting details

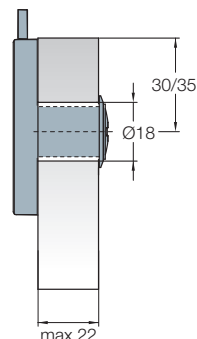
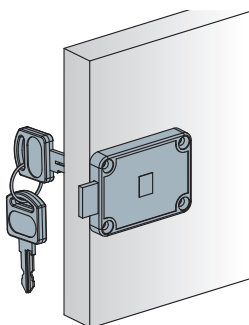

100 Sets

Chipboard screws for fixing  
611.8K16.240.020

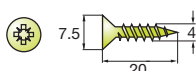

Download supporting documentation from the Titus Tekform website [titustekform.com.au](http://titustekform.com.au)

# Furniture Locks

## Cylinder Lock

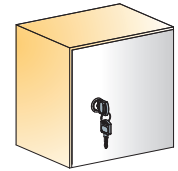

- Compact design for use on small furniture elements
- Screw-on mounting on door
- Left and right hand version available

|                 |                         |   |   |
|-----------------|-------------------------|---|---|
|                 |                         | <p>Left-hand</p>                              | <p>Right-hand</p>                             |
|                 |                         | <p>Item number</p> <p><b>110.7420.850</b></p> | <p>Item number</p> <p><b>110.7421.850</b></p> |
|                 |                         | <p>One set consists of</p> <p>Lock</p>        | <p>1 pce</p>                                  |
|                 |                         | <p>Rosette</p>                                | <p>1 pce</p>                                  |
|                 |                         | <p>Key</p>                                    | <p>1 pair</p>                                 |
| <p>Assembly</p> | <p>Mounting details</p> |   |   |
| <p>100 Sets</p> |                         |   |   |

Chipboard screws for fixing  
611.8K16.240.020

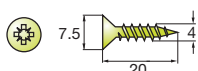

Download supporting documentation from the Titus Tekform website [titustekform.com.au](http://titustekform.com.au)

# Furniture Locks



## Cylinder Locks

|  | Lock type       | Key type | Keyed     | Item number    | Nickel Plated |
|--|-----------------|----------|-----------|----------------|---------------|
| <b>601 Rim Lock Housing with Barrel and Key</b><br>          | Rim             | Barrel   | Alike     | 605.8B10.601 → | 001           |
|  | Rim             | Barrel   | Alike     | 605.8B10.601 → | 002           |
|  | Rim             | Barrel   | Alike     | 605.8B10.601 → | 003           |
|  | Rim             | Barrel   | Alike     | 605.8B10.601 → | 004           |
|  | Rim             | Barrel   | Alike     | 605.8B10.601 → | 005           |
|  | Rim             | Barrel   | Alike     | 605.8B10.601 → | 006           |
|  | Rim             | Barrel   | Alike     | 605.8B10.601 → | 007           |
|  | Rim             | Barrel   | To Differ | 605.8B10.601 → | 000           |
|  1 Set  |                 |          |           |                |               |
| <b>628 Double Door Lock Housing with Barrel and Key</b><br> | Double Door Rim | Barrel   | Alike     | 605.8B10.628 → | 003           |
|  | Double Door Rim | Barrel   | Alike     | 605.8B10.628 → | 001           |
|  | Double Door Rim | Barrel   | Alike     | 605.8B10.628 → | 002           |
|  | Double Door Rim | Barrel   | To Differ | 605.8B10.628 → | 000           |
|  1 Set  |                 |          |           |                |               |
| <b>604 Push Lock Housing with Barrel and Key</b><br>        | Push            | Barrel   | Alike     | 605.8B10.604 → | 001           |
|  | Push            | Barrel   | Alike     | 605.8B10.604 → | 002           |
|  | Push            | Barrel   | To Differ | 605.8B10.604 → | 000           |
|  1 Set  |                 |          |           |                |               |

Download supporting documentation from the Titus Tekform website [titustekform.com.au](http://titustekform.com.au)





# Furniture Locks

## Cylinder Locks

|  |               | Lock type | Key type | Keyed     | Item number      |
|--|---------------|-----------|----------|-----------|------------------|
|  <p>611 Push Lock Housing with Barrel and Key</p>          |               | Cam       | Barrel   | Alike     | 605.8B10.611.001 |
|  |               | Cam       | Barrel   | Alike     | 605.8B10.611.002 |
|  |               | Cam       | Barrel   | Alike     | 605.8B10.611.003 |
|  |               | Cam       | Barrel   | Alike     | 605.8B10.611.004 |
|  |               | Cam       | Barrel   | Alike     | 605.8B10.611.005 |
|  |               | Cam       | Barrel   | To Differ | 605.8B10.611.000 |
|  1 Set  |               |           |          |           |                  |
|  <p>CC Series Lock with Removable Barrel, Keyed Alike</p> |               | Cam       | Barrel   | Alike     | 605.8B10.215.000 |
|  | Master Key    | Cam       | Barrel   |           | 605.8B10.205.000 |
|  | Removable Key | Cam       | Barrel   |           | 605.8B10.200.000 |
|  1 Set  |               |           |          |           |                  |

# Furniture Locks

## Striker Plates

|   |               | Item number      |
|---|---------------|------------------|
| <p>Right Angle Lock Striker Plate, 30mm</p>       |               | 605.8B10.600.030 |
|  1 Pce   | Made of steel |                  |
| <p>Standard Z Striker Plate for Double Door</p>  |               | 605.8B10.600.020 |
|  1 Pce   | Made of steel |                  |



# Espagnolette Lock with Rotating Bar

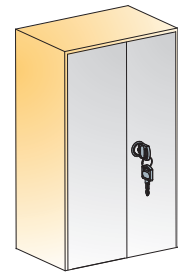

- Screw-on mounting on door
- Left and right hand version available

|                          |   |                                 |
|--------------------------|---|---------------------------------|
|                          | Left-hand   | Right-hand                      |
|                          |   |                                 |
|                          | Item number   | Item number                     |
|                          | 156.7430.850  | 156.7431.850                    |
|                          |   |                                 |
| <p>Assembly</p>          | <p>Mounting details</p>   |                                 |
|                          | One set consists of   |                                 |
| Lock                     |   | 1 pce                           |
| Rosette                  |   | 1 Pce                           |
| Key                      |   | 1 Pair                          |
| Staple (L+R)             |   | 1 Pce L<br>1 Pce R              |
| Hook (L+R)               |   | 1 Pce L<br>1 Pce R              |
| Striking plate           |   | 1 Pce D = 8mm<br>1 Pce D = 18mm |
| Bar guide                |   | 4 Pcs                           |
| Rotating bar<br>L=1000mm |   |                                 |
| Item number              | 190.2646.050.00   |                                 |
|                          |   |                                 |
|                          | <p>Bar length<br/>A = A<sub>1</sub> - 37<br/>B = B<sub>1</sub> - 37</p> |                                 |

100 Sets

Chipboard screws for fixing  
611.8K16.240.020

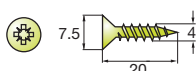

Download supporting documentation from the Titus Tekform website [titustekform.com.au](http://titustekform.com.au)

# Central Locking System

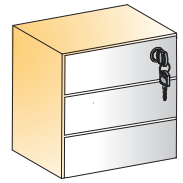

- Furniture lock with cylinder
- Screw-on mounting in front panel

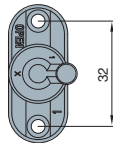
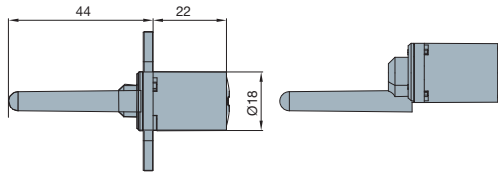

Assembly

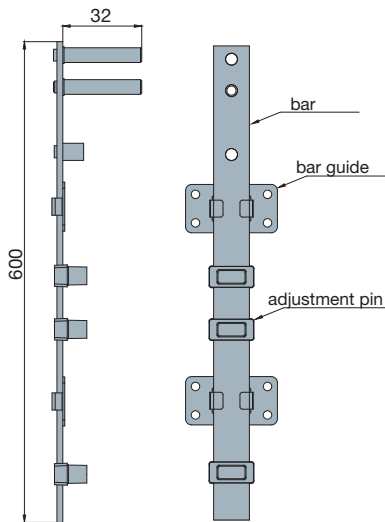

Mounting and drilling details

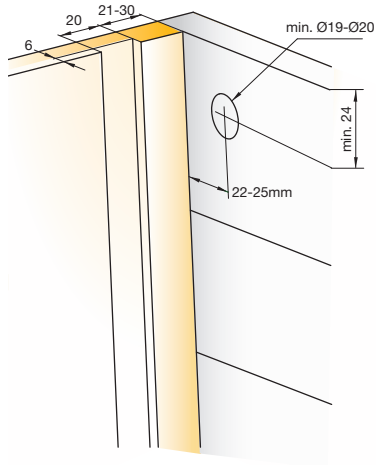

Item number

Lock 167.7440.850

Accessories 167.7449.050

One set consists of

Lock

1 pce



Rosette

1 pce



Key

1 pair



One set accessories consists of

Bar guide

3 pcs



Locking pin

3 pcs



Bar  
L= 600mm

1 pce



 100 Sets

Made of steel

Chipboard screws for fixing  
611.8K16.240.020

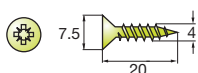



Download supporting documentation from the Titus Tekform website [titustekform.com.au](http://titustekform.com.au)

# Builders Hardware







## Waste Plates

- Cover for plumbing misplaced drilling
- Stick on around pipe to cover chips or oversized hole

|   | Size          | Item number     |
|---|---------------|-----------------|
| <b>Corna Plumbing Waste Plates</b>  | 210 x 295mm   | 605.838.210.295 |
|                         | 40mm          | 605.838.040.000 |
|   | 50mm          | 605.838.050.000 |
|   | 65mm          | 605.838.065.000 |
|   | Various       | 605.838.000.014 |
|  10 Pcs (000.014, Pkt) | Made of steel |                 |

# General Hardware & Tools







## Drill Bits

|   | Diameter (mm) | Item number      |                  |
|---|---------------|------------------|------------------|
| <b>Snappy Countersunk Drill Bit, Gold</b><br> | 1/8           | 605.8T60.000.018 |                  |
|  1 Pce                                       |               |                  |                  |
| <b>Jobber Drill Bit</b><br>                  | 5/64          | 605.8T50.343.564 |                  |
|   | 7/64          | 605.8T50.343.764 |                  |
|   | 1/18          | 605.8T50.343.180 |                  |
|   | 5/32          | 605.8T50.343.532 |                  |
|   | 3/32          | 605.8T50.343.332 |                  |
|  1 Pce                                       |               |                  |                  |
| <b>Philips Head Drill Bits</b><br>           | PH1           | 25               | 605.8T10.125.000 |
|   | PH2           | 25               | 605.8T10.225.000 |
|   | PH1           | 50               | 605.8T10.150.000 |
|   | PH2           | 50               | 605.8T10.250.000 |
|  10 Pcs                                      |               |                  |                  |

Download supporting documentation from the Titus Tekform website [titustekform.com.au](http://titustekform.com.au)

# General Hardware & Tools

## Drill Bits





|  |                          | Diameter (mm) | Item number      |
|--|--------------------------|---------------|------------------|
| <b>Pozidrive Drill Bit</b><br><br> 10 Pcs | PZ2                      | 25            | 605.8T10.325.000 |
|  | PZ2                      | 50            | 605.8T10.350.000 |
| <b>Power Drill Bit</b><br><br> 1 Pce     | PH2                      | 152           | 605.8T10.205.000 |
| <b>Tungsten Drill Bits, 57mm</b><br>  | Right-hand               | 5             | 605.8T40.157.105 |
|  | Left-hand                | 5             | 605.8T40.157.005 |
|  | Right-hand               | 8             | 605.8T40.157.008 |
|  | Left-hand                | 8             | 605.8T40.157.108 |
|  | Right-hand               | 10            | 605.8T40.257.010 |
|  | Left-hand                | 10            | 605.8T40.157.010 |
|  | Right-hand               | 35            | 605.8T40.257.035 |
|  1 Pce  | Made of tungsten carbide |               |                  |

Magnetic Drill Bit Holder  
**605.8T10.000.000**

Download supporting documentation from the Titus Tekform website [titustekform.com.au](http://titustekform.com.au)

# General Hardware & Tools







## Drill Twists

|   |  | Diameter (mm) | Item number      |
|---|--|---------------|------------------|
| Twist Drill Bit, Imperial<br> |  | 1/8           | 605.8T50.343.018 |
|  10 Pcs                      |  |               |                  |
| Drill Twists, Metric<br>     |  | 2.5           | 605.8T50.343.025 |
|   |  | 3             | 605.8T50.343.030 |
|   |  | 3.5           | 605.8T50.343.035 |
|   |  | 4             | 605.8T50.343.040 |
|   |  | 5             | 605.8T50.343.050 |
|  10 Pcs                      |  |               |                  |

Download supporting documentation from the Titus Tekform website [titustekform.com.au](http://titustekform.com.au)



# General Hardware & Tools

## Saw Blades



|   | Teeth | Style | Cut direction | Item number      |
|---|-------|-------|---------------|------------------|
| <b>Makita Jigsaw Blades, 5 pack</b><br> | 2.9   | B10   | Upward cut    | 605.8T41.010.000 |
|   | 2.8   | B11   | Upward cut    | 605.8T41.011.000 |
|   | 4.2   | B12   | Upward cut    | 605.8T41.012.000 |
|   | 2.1   | B19   | Downward cut  | 605.8T41.019.000 |
|  1 Pkt                                 |       |       |               |                  |
| <b>Jigsaw Blades</b><br>               | 4.0   | T144D | Upward cut    | 605.8T40.144.000 |
|  1 Pkt                                 |       |       |               |                  |
| <b>Reversible Planer Saw Blade</b><br> |       |       |               | 605.8T35.000.050 |
|  1 Pkt                                 |       |       |               |                  |

# General Hardware & Tools

## Files

|  |  | Item number      |
|--|--|------------------|
| Handy Files  |  | 605.8T70.000.000 |
|  12 Pcs |  |                  |

## Storage Boxes

|   |                       | Item number      |
|---|-----------------------|------------------|
|        | Exacta Pack - Large   | 605.8T90.015.000 |
|   | Multi 10 pack - Small | 605.8T90.020.000 |
|  1 Pce | Made of plastic       |                  |

Download supporting documentation from the Titus Tekform website [titustekform.com.au](http://titustekform.com.au)



# General Hardware & Tools

## Liquid Laminate

Liquid Laminate, 15ml





| Colour             | Item number      |
|--------------------|------------------|
| White              | 605.8L50.301.001 |
| Black              | 605.8L50.301.002 |
| Marl Beige         | 605.8L50.301.003 |
| Antique White      | 605.8L50.301.004 |
| Parchment          | 605.8L50.301.005 |
| Charcoal           | 605.8L50.301.006 |
| Folk / Oyster Grey | 605.8L50.301.007 |
| Alabaster          | 605.8L50.301.008 |
| Classic Beige      | 605.8L50.301.009 |
| Cuppacino          | 605.8L50.301.010 |
| Mushroom Linea     | 605.8L50.301.011 |
| Oyster Linea       | 605.8L50.301.012 |
| Paperbark          | 605.8L50.301.013 |
| Silver Grey        | 605.8L50.301.014 |
| Stone Beige        | 605.8L50.301.015 |
| Select Beech       | 605.8L50.301.028 |
| Young Beech        | 605.8L50.301.036 |
| Wenge              | 605.8L50.301.037 |

 1 Pkt

# General Hardware & Tools

## Repair Crayons

- 12 crayons in each pack
- Available in a variety of colours
- Hide small damage done to furniture

|  | Colour           | Item number      |
|--|------------------|------------------|
| <p>Repair Crayons</p>  | Various Colours  | 605.8L50.300.000 |
|  | White            | 605.8L50.300.001 |
|  | Black            | 605.8L50.300.002 |
|  | Marl Beige       | 605.8L50.300.003 |
|  | Antique White    | 605.8L50.300.004 |
|  | Parchment        | 605.8L50.300.005 |
|  | Gunmetal         | 605.8L50.300.006 |
|  | Folk/Oyster Grey | 605.8L50.300.007 |
|  | Ironstone        | 605.8L50.300.008 |
|  | Baltic Pine      | 605.8L50.300.010 |
|  | Birch            | 605.8L50.300.012 |
|  | Cherry           | 605.8L50.300.014 |
|  | Dark Teak        | 605.8L50.300.016 |
|  | Dark Walnut      | 605.8L50.300.018 |
|  | Graceful Oak     | 605.8L50.300.020 |
|  | Jarrah           | 605.8L50.300.022 |
|  | Light Teak       | 605.8L50.300.024 |
|  | Red Cherry       | 605.8L50.300.026 |
| Select Beech   | 605.8L50.300.028 |                  |
| Tasmanian Oak  | 605.8L50.300.030 |                  |
| Walnut   | 605.8L50.300.032 |                  |
| Wild Birch   | 605.8L50.300.034 |                  |
| Young Beech  | 605.8L50.300.036 |                  |
|  12 Pcs               |                  |                  |

Download supporting documentation from the Titus Tekform website [titustekform.com.au](http://titustekform.com.au)

# General Hardware & Tools

## Filler

- Water-based
- 4-in-1 Woodputty, Grainfiller, Edgefiller and Crackfiller
- Non-flammable, non-toxic and can be used to the last gram

|   | Size (kg) | Colour   | Item number      |
|---|-----------|----------|------------------|
| <p>Timbermate Filler</p>  | 2         | Ebony    | 605.8L50.302.202 |
|   | 2         | Hardwood | 605.8L50.302.203 |
|   | 8         | Hardwood | 605.8L50.302.803 |
|   | 2         | Oak      | 605.8L50.302.230 |
|   | 2         | Pine     | 605.8L50.302.210 |
|   | 8         | Pine     | 605.8L50.302.810 |
|   | 2         | Teak     | 605.8L50.302.224 |
|   | 2         | Walnut   | 605.8L50.302.232 |
|   | 2         | White    | 605.8L50.302.201 |

 1 Pce

# General Hardware & Tools

## Stan the Stand







- For tradesman usage
- Materials handling

|  |  | Item number                    |
|--|--|--------------------------------|
| Stan the Stand   |  | 605.8T90.000.000               |
|  |  | Extension Kit 605.8T90.005.000 |
|  |  | PVC Covers 605.8T90.010.000    |
|  |  |                                |

 1 Pair

# General Hardware & Tools

## Safety Materials

|   | Item number      |
|---|------------------|
| <p>Nuisance Dust Mask</p>  <p> 50 Pcs</p>                                    | 605.8T90.035.000 |
| <p>Disposable Respirator with Valve, 12 pack</p>  <p> 1 Box</p>             | 605.8T90.040.000 |
| <p>Pro-plug Disposable Ear Plugs,<br/>Uncorded, 200 Pair</p>  <p> 1 Box</p> | 605.8T90.045.000 |